

**FEATURES:**

1. Material: Tin Plated CU
2. UL listed for U.S. & Canada.
3. Wire connector rated for 35Kv max.
4. Class B/C compressed, concentric, and compact copper conductor only.
5. Expanded wire range when installed with dieless NSi compression tool (N12ID).
6. Dimensions are for reference only, tolerance is +/- .06".

# LN Series: L6N-14



PROGRAM:	SOLIDWORKS
UPDATED:	4/2022
SALES REV:	A
SIZE:	B (11x17)

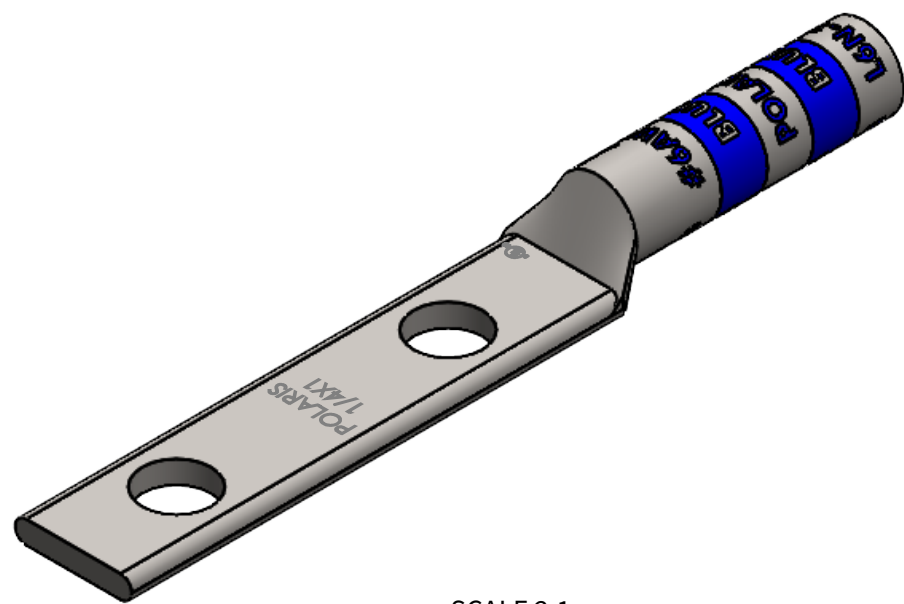

SCALE 2:1

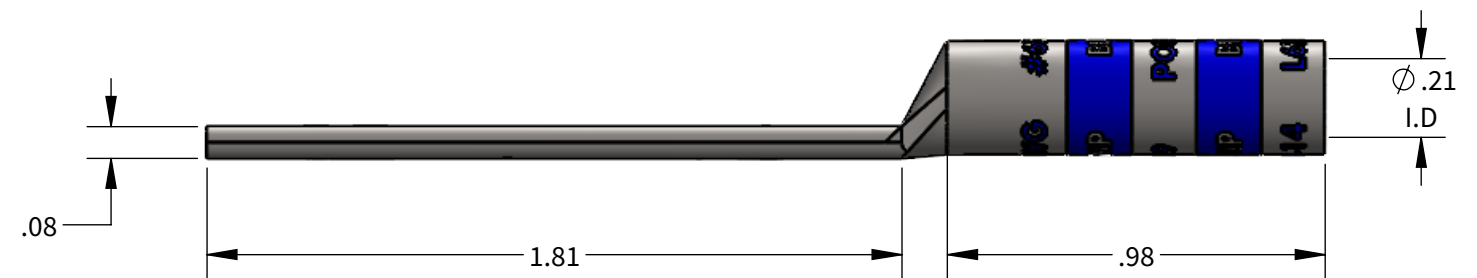
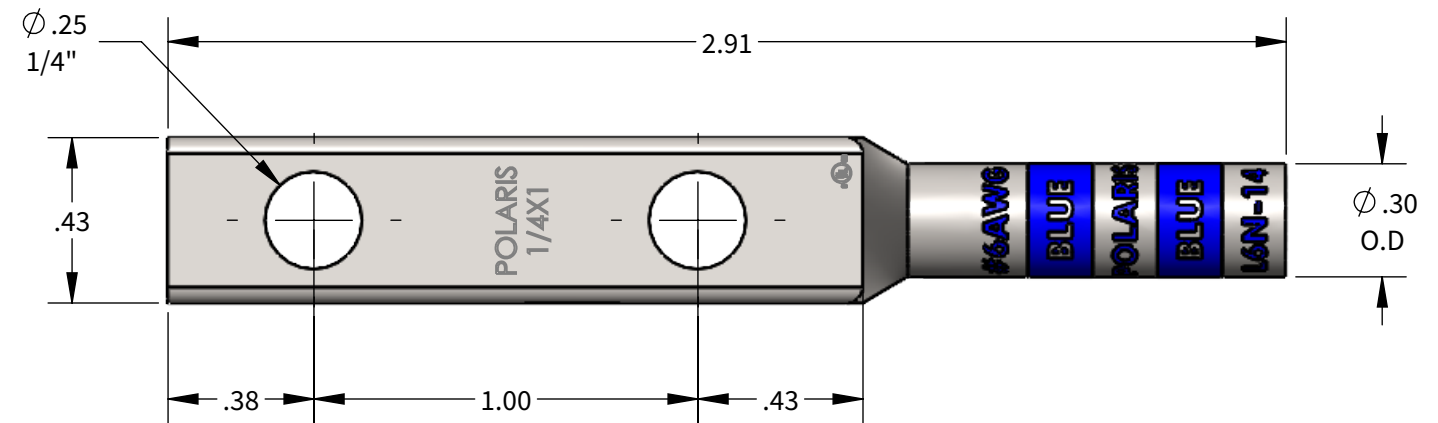

COPPER COMPRESSION CONNECTOR TOOL AND DIE CHART (# OF CRIMPS)

			COPPER COMPRESSION CONNECTOR TOOL AND DIE CHART (# OF CRIMPS)										
			NSI			GREENLEE		ILSCO	BURNDY	T&B	HUSKIE		
WIRE SIZE	STRIP LENGTH	DIE COLOR	EXPANDED WIRE RANGE W/N12ID	N1240 SERIES	NSI-12	NSI-12	1240 SERIES		ILC-12/ILC-15 SERIES	Y-35, Y750, PAT 750	TBM-15, TBM-14M	EP510C	
#6AWG	1-1/16"	BLUE	#6AWG-#8AWG	KC12-6 (2)	CD2 (4)	HT41GL (4)	KC12-6 (2)	ILD-2 (4)	KC12-6(2)	U5CRT (2)	15522 (4)	HT41GL (4)	CD2 (4)

