

FEATURES:

1. Material: Tin Plated CU
2. UL listed for U.S. & Canada.
3. Wire connector rated for 35Kv max.
4. Class B/C compressed, concentric, and compact copper conductor only.
5. Expanded wire range when installed with dieless NSi compression tool (N12ID).
6. Dimensions are for referene only.

L Series: L1038



PROGRAM:	SOLIDWORKS
UPDATED:	4/2022
SALES REV:	A
SIZE:	B (11x17)

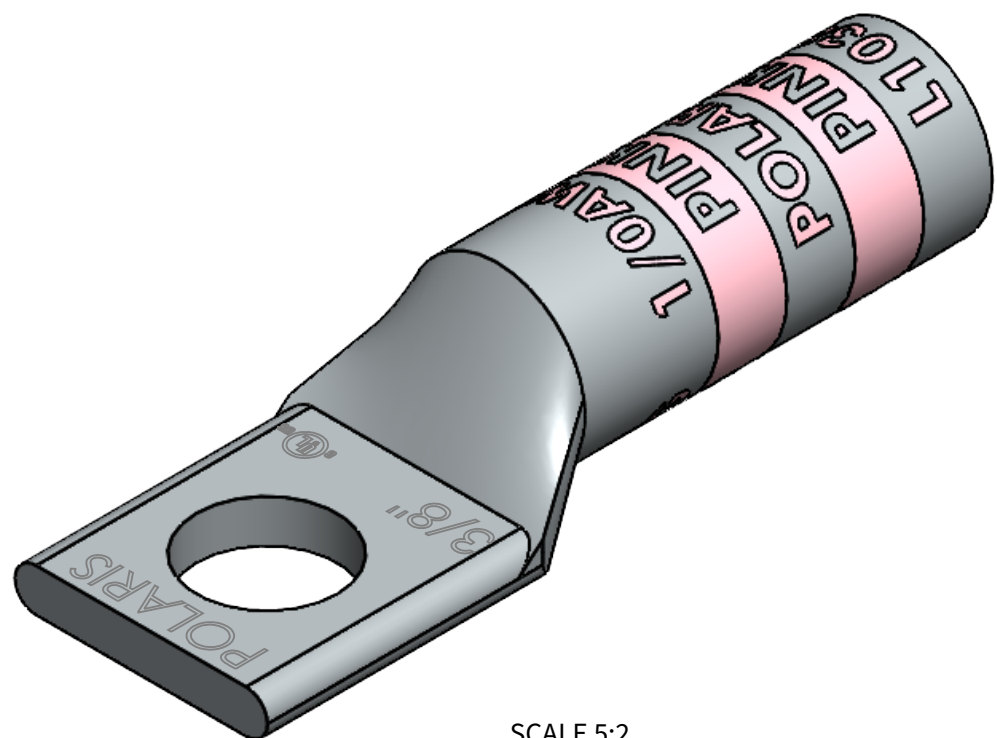

SCALE 5:2

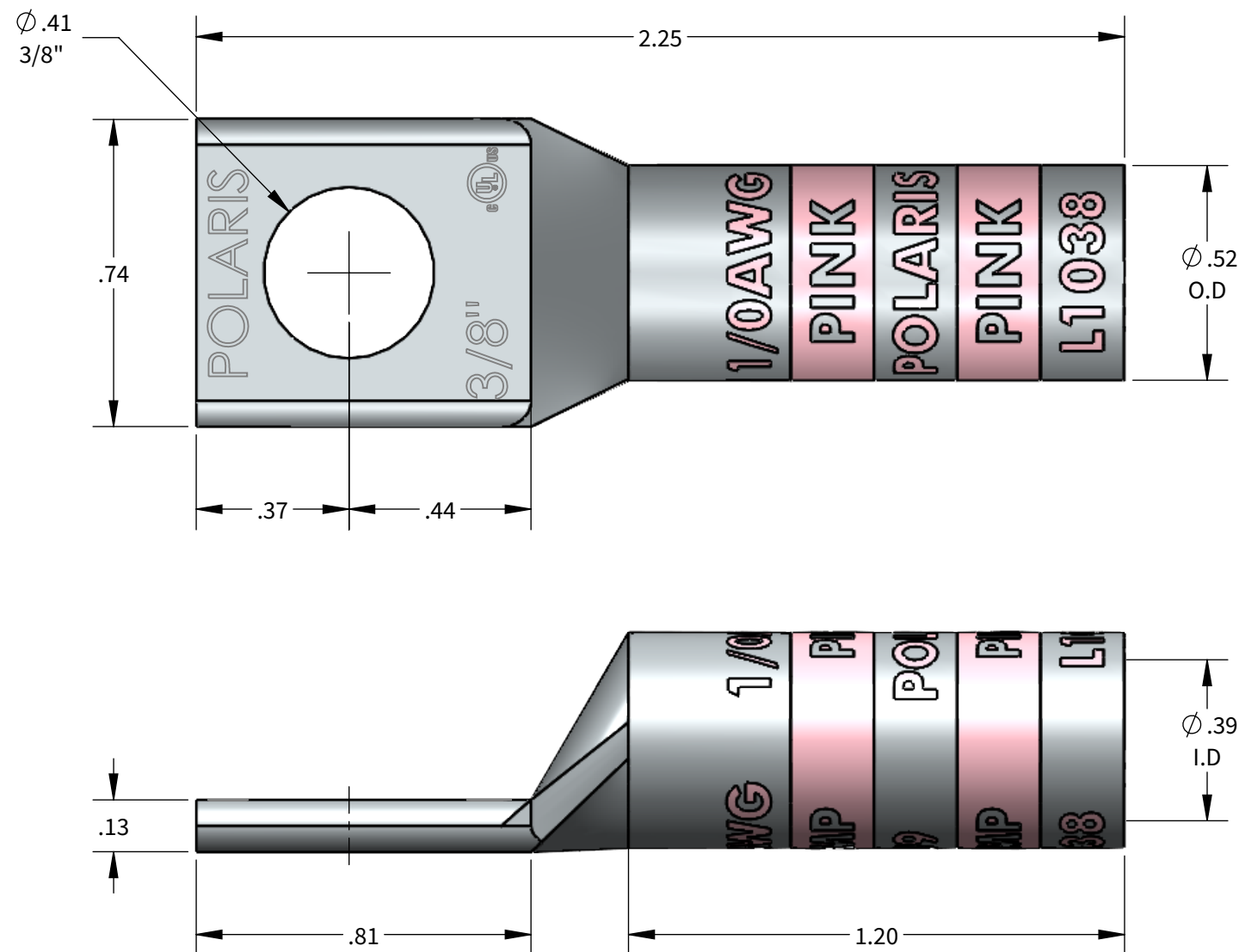

COPPER COMPRESSION CONNECTOR TOOL AND DIE CHART (# OF CRIMPS)

WIRE SIZE	STRIP LENGTH	DIE COLOR	EXPANDED WIRE RANGE W/N12ID	NSI		GREENLEE	ILSCO	BURNDY	T&B	HUSKIE			
				N1240 SERIES	NSI-12	NSI-12	1240 SERIES	ILC-12/ILC-15 SERIES	Y-35, Y750, PAT 750	TBM-15, TBM-14M	EP510C		
1/0AWG	1-1/4"	PINK	1/0AWG-#6AWG	KC12-1/0 (2)	CD6 (4)	HT41AY (4)	KC12-1/0 (2)	ILD-5 (4)	KC12-1/0 (2)	U25RT (2)	15508 (4)	HT41AY (4)	CD6 (4)

