

FEATURES:

1. Material: Tin Plated CU
2. UL listed for U.S. & Canada.
3. Wire connector rated for 35Kv max.
4. Class B/C compressed, concentric, and compact copper conductor only.
5. Expanded wire range when installed with dieless NSi compression tool (N12ID).
6. Dimensions are for reference only, tolerance is +/- .06".

GL Series: GL2038



PROGRAM:	SOLIDWORKS
UPDATED:	4/2022
SALES REV:	A
SIZE:	B (11x17)

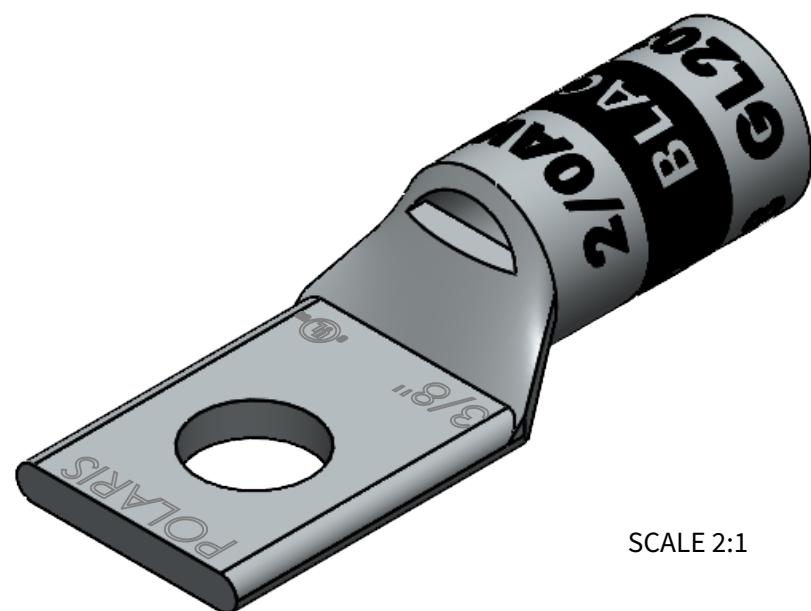

SCALE 2:1

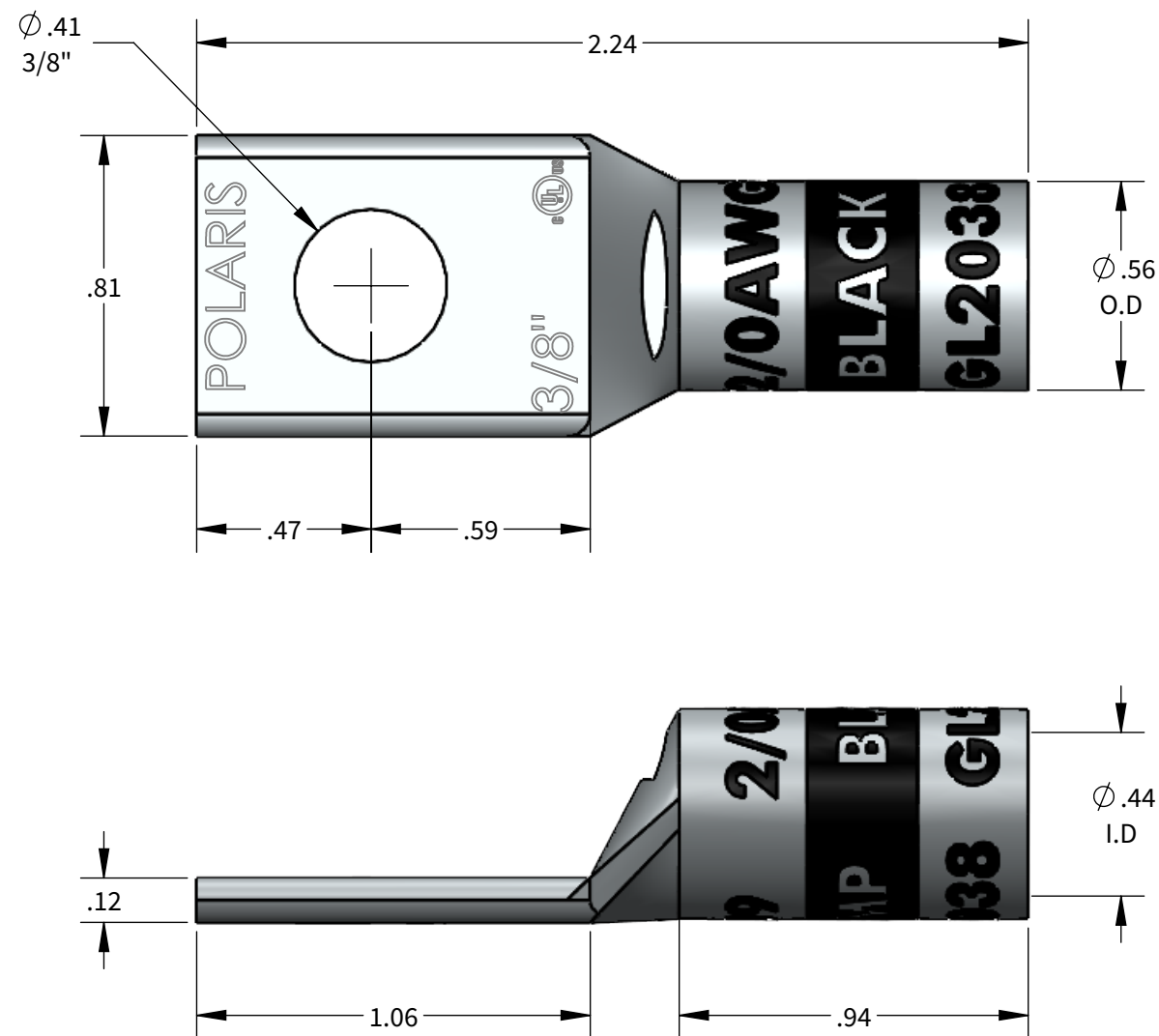

COPPER COMPRESSION CONNECTOR TOOL AND DIE CHART (# OF CRIMPS)

		COPPER COMPRESSION CONNECTOR TOOL AND DIE CHART (# OF CRIMPS)										
		NSI			GREENLEE		ILSCO	BURNDY	T&B	HUSKIE		
WIRE SIZE	STRIP LENGTH	DIE COLOR	EXPANDED WIRE RANGE W/N12ID	N1240 SERIES	NSI-12	NSI-12	1240 SERIES	ILC-12/ILC-15 SERIES	Y-35, Y750, PAT 750	TBM-15, TBM-14M	EP510C	
2/0AWG	1"	BLACK	2/0AWG-#4AWG	KC12-2/0 (1)	CD7 (2)	HT41AZ (2)	KC12-2/0 (1) ILD-6 (2)	KC12-2/0 (1)	U26RT (1)	15526 (2)	HT41AZ (2)	CD7 (2)

