

FEATURES:

1. Material: Tin Plated CU
2. UL listed for U.S. & Canada.
3. Wire connector rated for 35Kv max.
4. Class B/C compressed, concentric, and compact copper conductor only.
5. Expanded wire range when installed with dieless NSi compression tool (N12ID).
6. Dimensions are for reference only, tolerance is +/- .06".

GL Series: GL1048



PROGRAM:	SOLIDWORKS
UPDATED:	4/2022
SALES REV:	A
SIZE:	B (11x17)

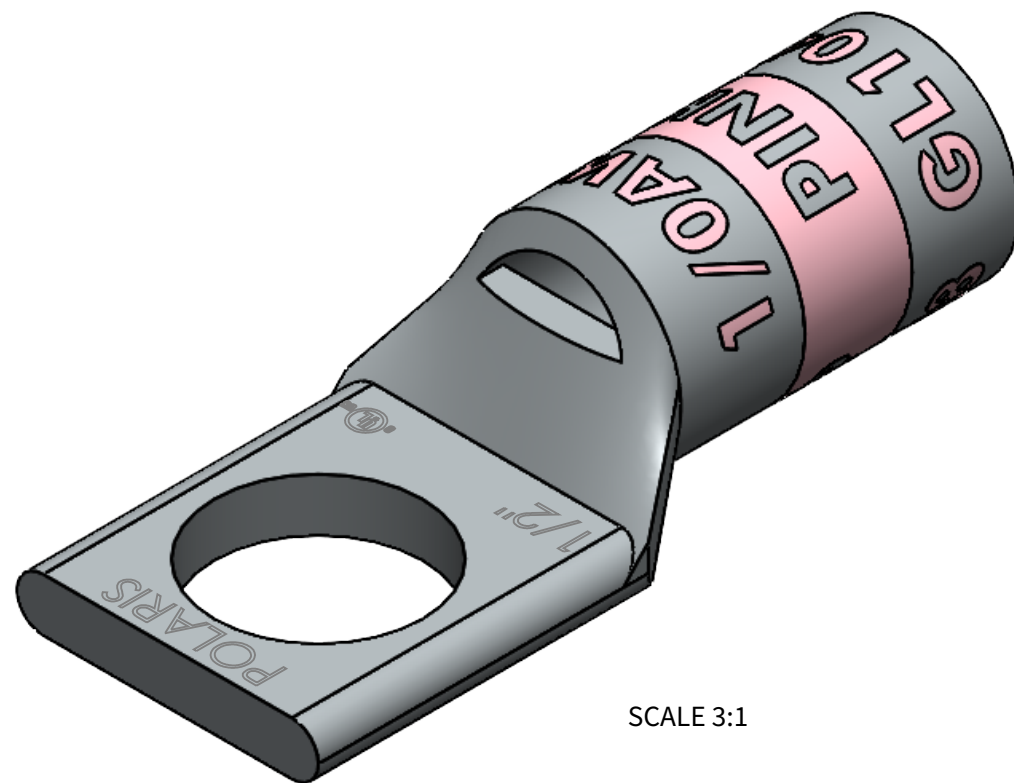

SCALE 3:1

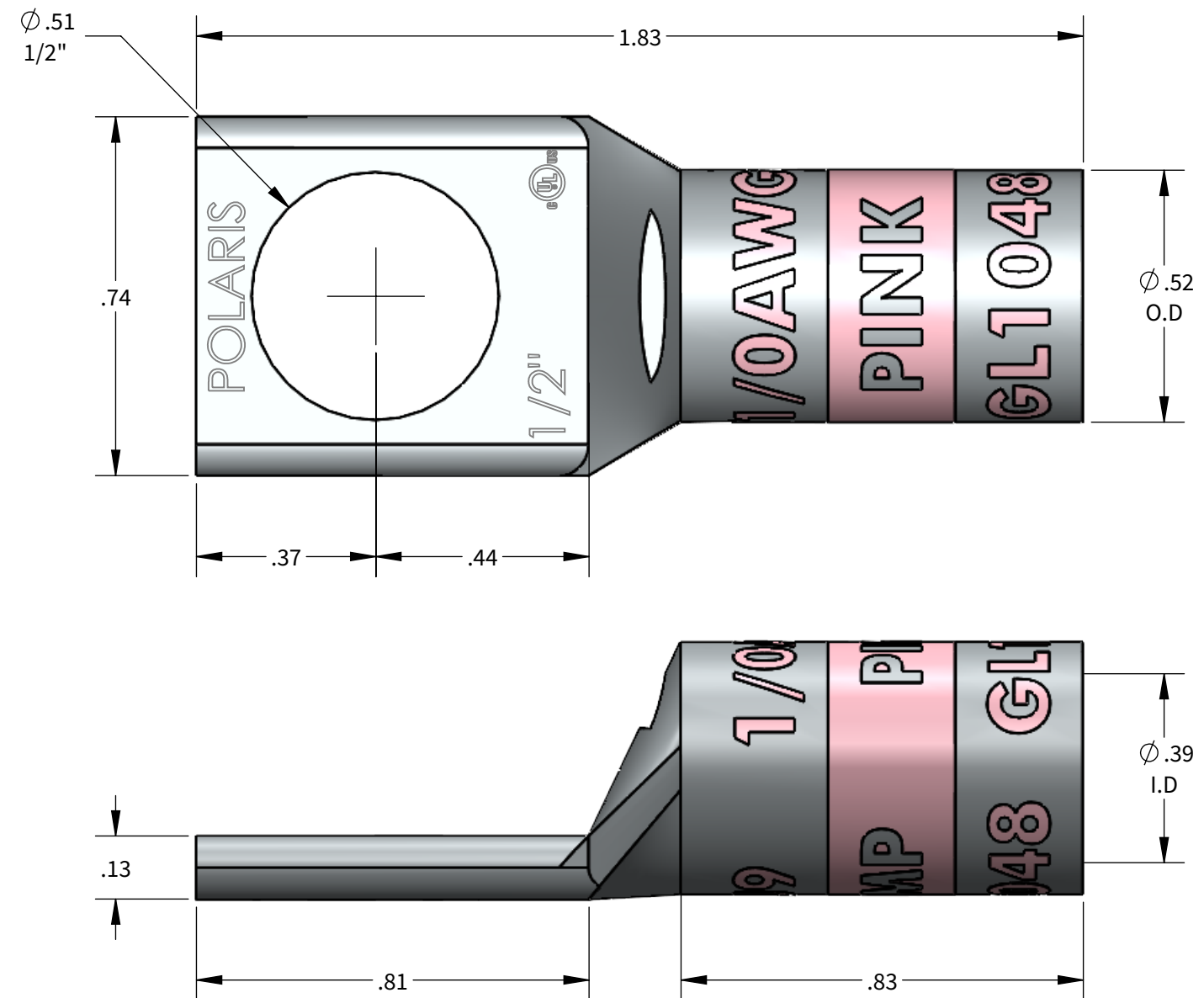

COPPER COMPRESSION CONNECTOR TOOL AND DIE CHART (# OF CRIMPS)

			NSI						GREENLEE		ILSCO	BURNDY	T&B	HUSKIE	
WIRE SIZE	STRIP LENGTH	DIE COLOR	EXPANDED WIRE RANGE W/N12ID	N1240 SERIES	NSI-12	NSI-12	1240 SERIES		ILC-12/ILC-15 SERIES	Y-35, Y750, PAT 750	TBM-15, TBM-14M	EP510C			
1/0AWG	15/16"	PINK	1/0AWG-#6AWG	KC12-1/0 (1)	CD6 (2)	HT41AY (2)	KC12-1/0 (1)	ILD-5 (2)	KC12-1/0 (1)	U25RT (1)	15508 (2)	HT41AY (2)	CD6 (2)		

